

Classroom Select® Contemporary Four Leg Chair with Casters

Chrome Frame



Black Frame



Optional Seat and Back Pads



Back of Chair



A perfect fit for every body, the Classroom Select® Contemporary® Four Leg Chair with Casters puts ergonomics - and mobility - at the forefront (and back) with thoughtfully-designed contoured ribs at the backrest for posture-enhancing lumbar support, and a headrest/upper back that flexes as the sitter leans or turns for natural movement throughout the day. Combine that with rubber-wheeled swivel casters a soft-but-durable polypropylene shell and tubular steel frame legs and you have a winning solution for keeping students from ages 5 to 18 at work and at ease throughout the entire school year.



FEATURES

- Shell and tubular steel frame is ergonomically designed to offer upper back and lumbar support
- Waterfall edge promotes good circulation and relieves pressure points
- 15 contoured ribs provide greater flexibility at the upper back while supporting the lower back
- Convenient integral handle in the upper back for easy carrying
- Chairs in 18"A+ seat heights provide a wider, more accommodating shell size
- Comes standard with 2" diameter hooded, swivel casters with rubber wheels
- Seat and back pads available for 18", 18"A+ and chairs
- Stack chairs up to 4 high to save storage space
- Optional field installed book baskets available for 18"A+ and 18" sizes
- Easy to clean with soap, water, and an optional diluted bleach solution
- Quickship available for select sizes and colors
- Ships assembled

SPECIFICATIONS

CONSTRUCTION

- 18"A+ frames are constructed from 1 $\frac{1}{8}$ ", 16-gauge tubular steel; all other sizes are formed from 1 $\frac{1}{8}$ ", 18-gauge steel
- Frame finishes available in durable, nickel-plated chrome or black powdercoat
- Shell is made of long lasting, injected-molded polypropylene

MODEL

MODEL	ITEM NUMBER	SHELL SIZE	FRAME FINISH	SEAT HEIGHT (IN)	CHAIR HEIGHT (IN)	SEAT WIDTH (IN)	SEAT DEPTH (IN)	FRAME WIDTH (IN)	FRAME DEPTH (IN)
18 in A+ Chair	1388743	Extra Wide	Chrome	18 A+	31.25	16	17	21.5	21.75
18 in A+ Chair	1425583	Extra Wide	Black	18 A+	31.25	16	17	21.5	21.75
18in A+ Chair with Seat and Back Pad	1441244	Extra Wide	Chrome	18 A+	31.25	16	17	21.5	21.75
18in A+ Chair with Seat and Back Pad	1441245	Extra Wide	Black	18 A+	31.25	16	17	21.5	21.75
18 in Chair	1388744	Standard	Chrome	18	31.25	15	16	17.5	20.5
18 in Chair	1425584	Standard	Black	18	31.25	15	16	17.5	20.5
18in A Chair with Seat and Back Pad	1441246	Standard	Chrome	18	31.25	15	16	17.5	20.5
18in A Chair with Seat and Back Pad	1441247	Standard	Black	18	31.25	15	16	17.5	20.5
16 in Chair	1496341	Medium	Chrome	16	27.5	13	13.5	15.25	18.75
16 in Chair	1497924	Medium	Black	16	27.5	13	13.5	15.25	18.75
14 in Chair	1496339	Small	Chrome	14	24.25	11.5	12	13.75	18
14 in Chair	1497923	Small	Black	14	24.25	11.5	12	13.75	18

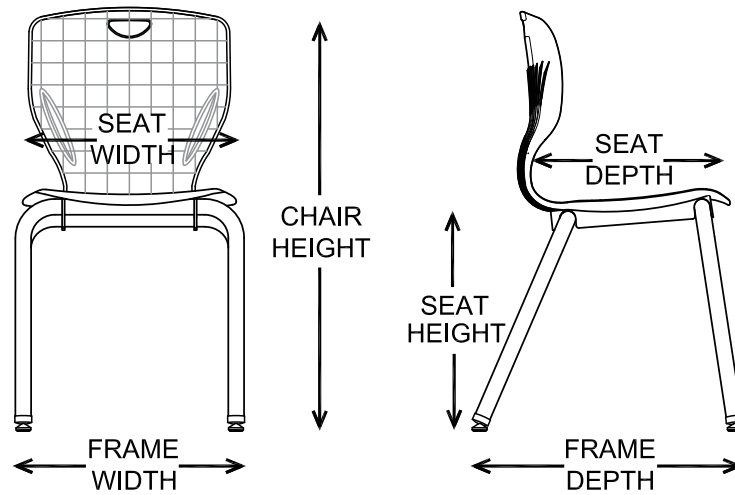

SHELL COLOR OFFERINGS

SEAT COLORS



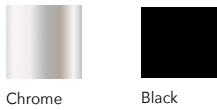

FRAME COLORS

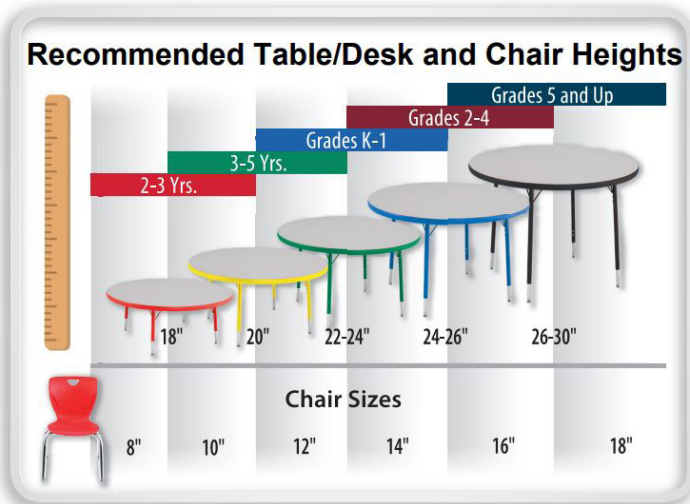
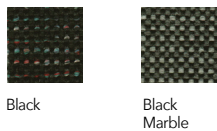

PADDED SEAT & BACK COLORS

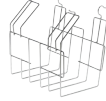
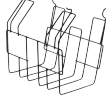

ACCESSORIES

MODEL	ITEM NUMBER	IMAGE
Chrome Wire Book Basket *Only available for 18 A+, and 18	1362136	
Black Wire Book Basket *Only available for 18 A+, and 18	1441266	
Adjustable Height Chair Dolly	1496629	



PRODUCT CERTIFIED
FOR LOW CHEMICAL
EMISSIONS:
UL COM/IGG
UL 2818